



TECHNICAL DATASHEET

TAB POLAR TRUCK TR20B

ORDER INFORMATION

TAB ID
154913

Short code
TR20B

DIN marking
70032

EAN Code
3838807040649

Quantity per EU/CNT pallet
21/28 pcs

TECHNOLOGY

Primary Function
Engine Start

Battery Technology
Flooded

Grid type (pos/neg)
Casted/Concasted

Grid alloy (pos/neg)
Sb/Ca

Separator
PE

Electrolyte (g/cm³)
1,28

TECHNICAL INFORMATION

Voltage (V)
12

Capacity C20 (Ah)
200

CCA -18°C EN (A)
1200

RC (min)
409

LxWxH (mm)
512x222x194/221

Total weight (kg)
45.0

BOX DESIGN

Box Type
B

Cover Type
Flat

Colour
Black

Layout
3

BHD
B0

Terminal
1

DRAWING

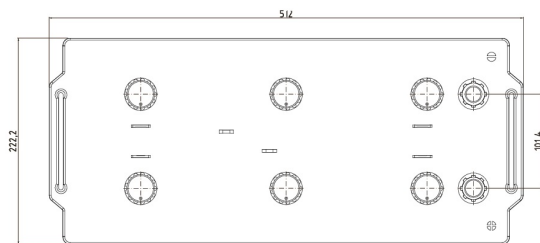
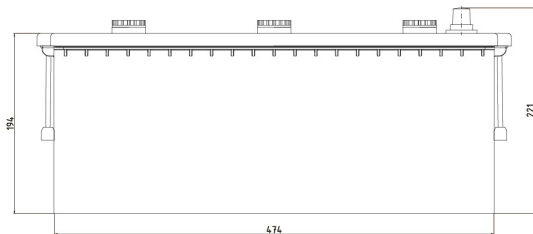

BHD



LAYOUT

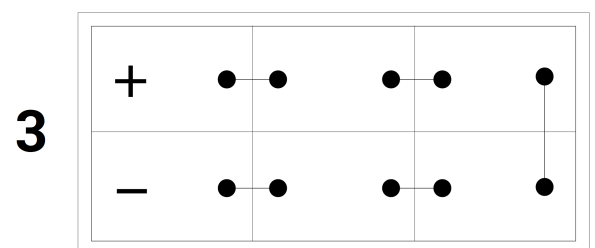

TERMINAL

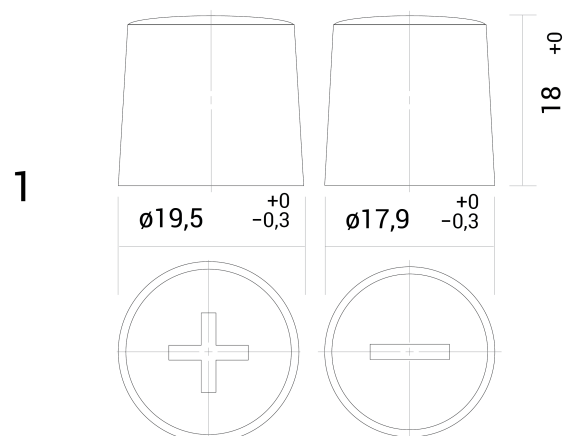

TECHNICAL DATASHEET

TAB POLAR TRUCK TR20B