



TECHNICAL DATASHEET

TAB AGM STOP&GO AG80

ORDER INFORMATION

TAB ID
213080

Short Code
AG80

DIN Marking
L4 AGM

EAN Code
3838807027305

Quantity per EU/CNT pallet
42/60 pcs

TECHNOLOGY

Primary Function
Advanced Start/Stop Functionality

Battery Technology
AGM - Absorbent Glass Mat

Grid Type (pos/neg)
Casted/Concasted

Grid Alloy (pos/neg)
Ca/Ca

Separator
GM

Electrolyte (g/cm³)
1,3

TECHNICAL INFORMATION

Voltage (V)
12

Capacity C20 (Ah)
80

CCA -18°C EN (A)
800

RC (min)
151

LxWxH (mm)
315x175x190

Total Weight (kg)
23.2

BOX DESIGN

Box Type
L4

Cover Type
Sealed

Colour
Black

Layout
0

BHD
B13

Terminal
1

DRAWING

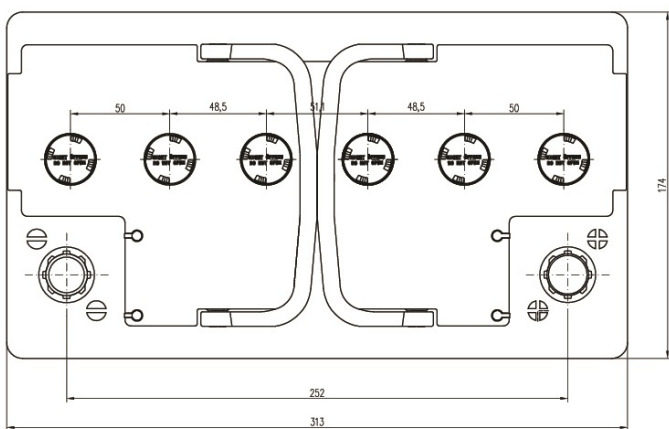
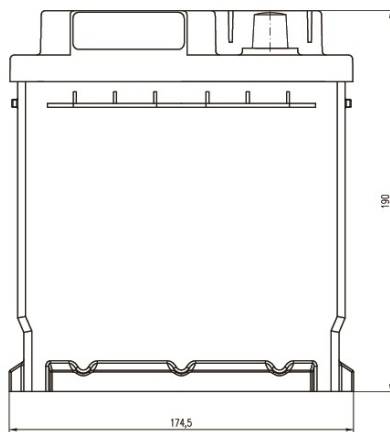
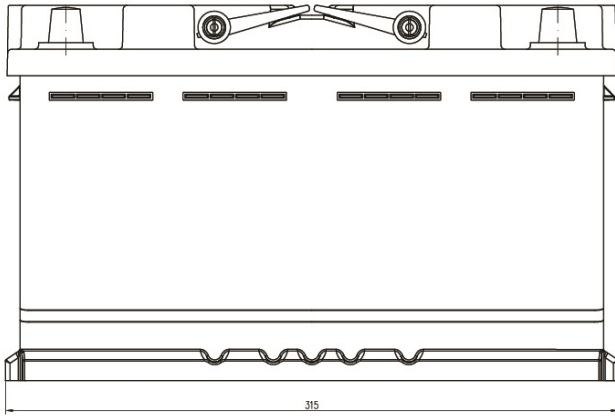

BHD



LAYOUT



TERMINAL



TECHNICAL DATASHEET

TAB AGM STOP&GO AG80